

PRODUCT FEATURES

- Seamless Spot Free Illumination
- Ultra Slim Profile
- Close Pitch LEDs
- Perfected Color Consistency
- Even Surface Illumination
- Multiple Lengths for Easy Configuration
- End to End Snap-In Connection
- Dimmable
- Side-Feed Units for Long Continuous Runs

PRODUCT SPECIFICATIONS

- 24V DC Constant Voltage Feelux or Approved Class 2 Drivers
- Operating Temperature : 0-45°C
- Lamp Life : 50,000 hrs L70
- Available Color : 2700K, 3000K, 3500K, 4000K
- CRI/Ra > 90
- 83.5lm/W – 3.9W/ft – 327lm/ft (NDPro 15W 4000K)
- IP20 – Damp Location/Closet Approved
- Beam Angle : 120°
- Finish : Aluminum
- 3 year warranty
- Product is approved for Closet/Storage space installation per NEC410.16 (A) (3) and NEC410.16 (C)(5) per NRTL certification

DIMENSIONS

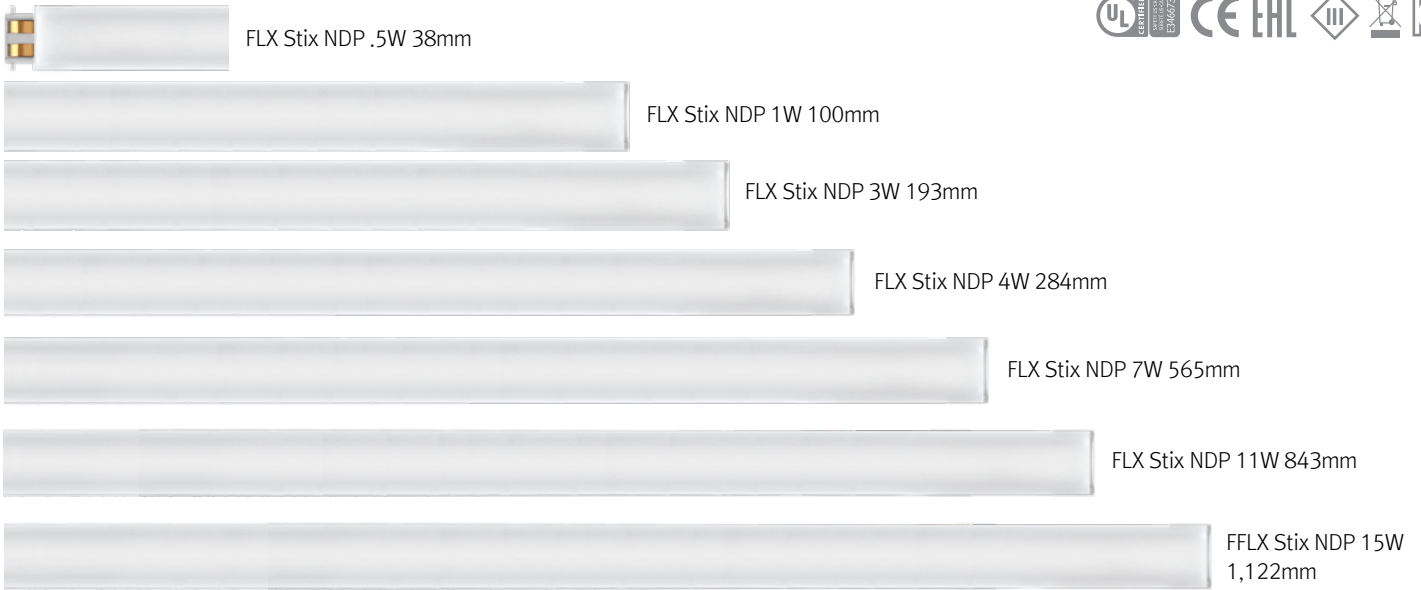

Model Number	Voltage Input (V)	Power Input (W)	Luminous Flux (lm) / 4000K	Color Rendering	A (mm)	B (mm)	C (mm)
NDP1-(Color)K-24V-C90-L38	DC24	0.49	41.9	Ra>90	33	38	55
NDP1-(Color)K-24V-C90	DC24	1.2	93.6	Ra>90	95	100	117
NDP3-(Color)K-24V-C90	DC24	2.37	186.9	Ra>90	188	193	210
NDP4-(Color)K-24V-C90	DC24	3.59	290.3	Ra>90	279	284	301
NDP7-(Color)K-24V-C90	DC24	7.17	568.4	Ra>90	560	565	582
NDP11-(Color)K-24V-C90	DC24	10.62	857.5	Ra>90	838	843	860
NDP15-(Color)K-24V-C90	DC24	14.42	1,203	Ra>90	1,117	1,122	1,139

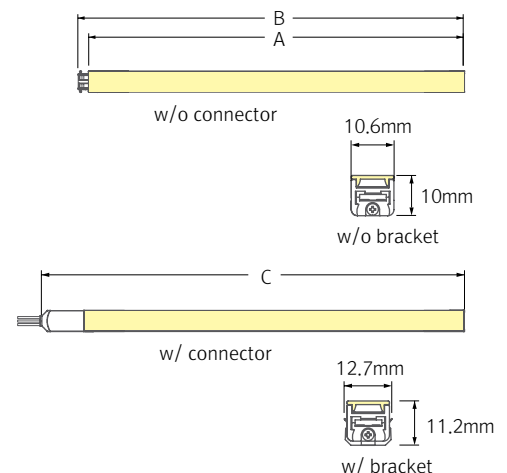

EASY CONNECTION

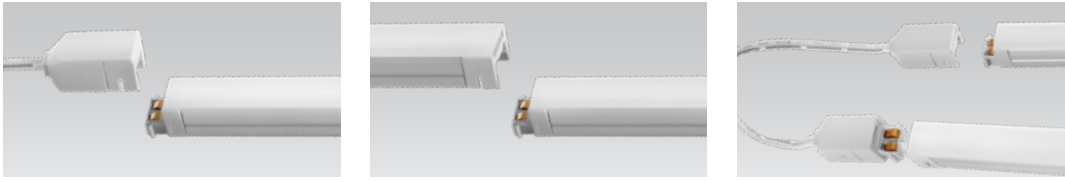

MAGNET

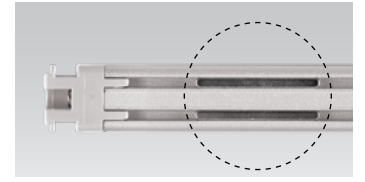

OPTIONS



INSTALLATION

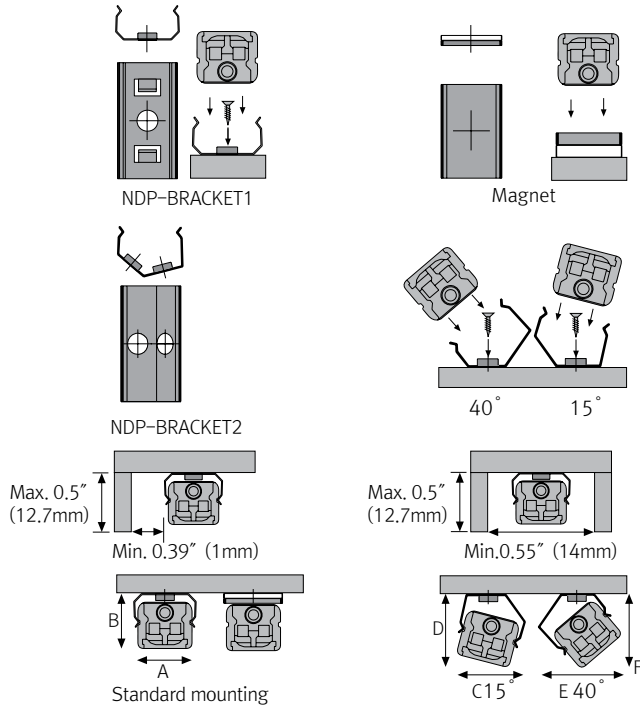

DIMENSION

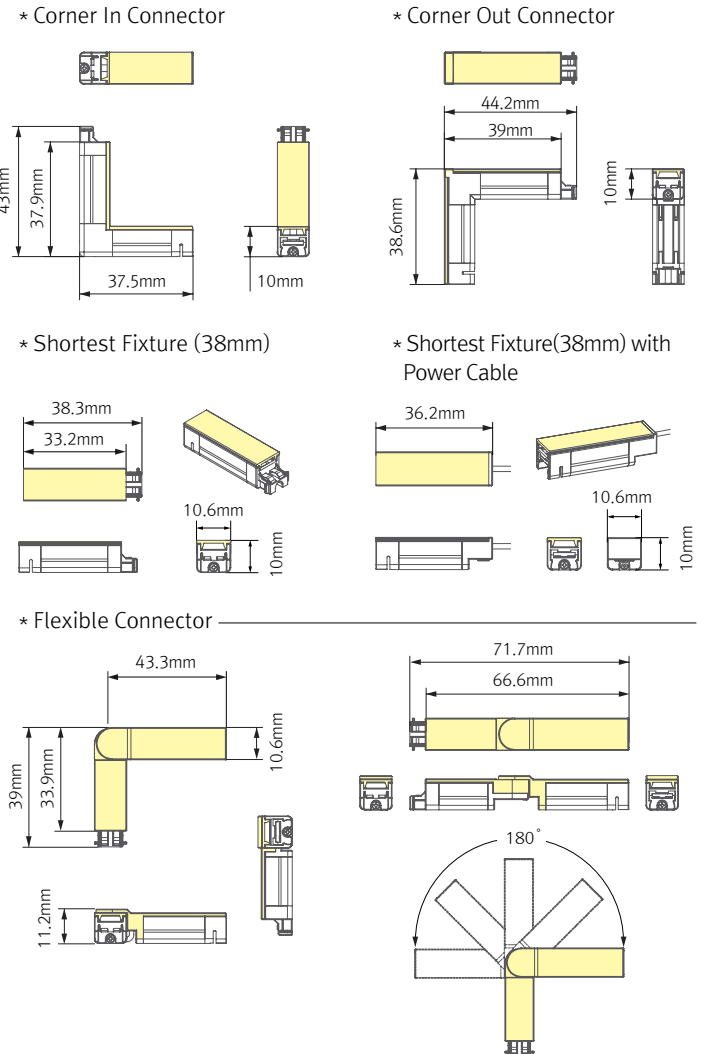

INLINE DIMMER

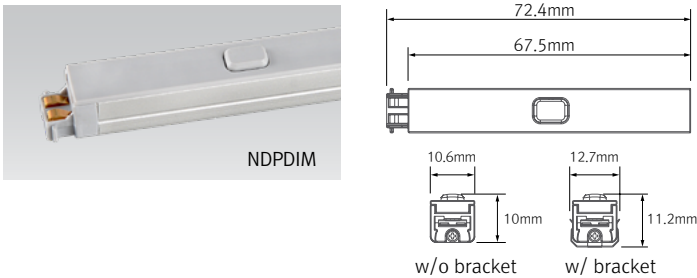

LED DRIVER OPTIONS

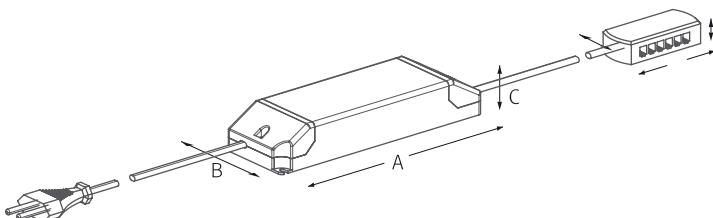

Model Name	A (mm)	B (mm)	C (mm)
FLC30-24V/T	150	41	31
FLC75-24V/T	180	60	32

CONNECTION

NO RUN TO EXCEED 55W

IF LONGER RUNS ARE REQUIRED USE SIDE FEED UNIT NDP3-(COLOR)K-24V-S TO CONTINUE SEAMLESS LIGHTING. NOT TO EXCEED 90% OF DRIVER RATED WATTAGE.

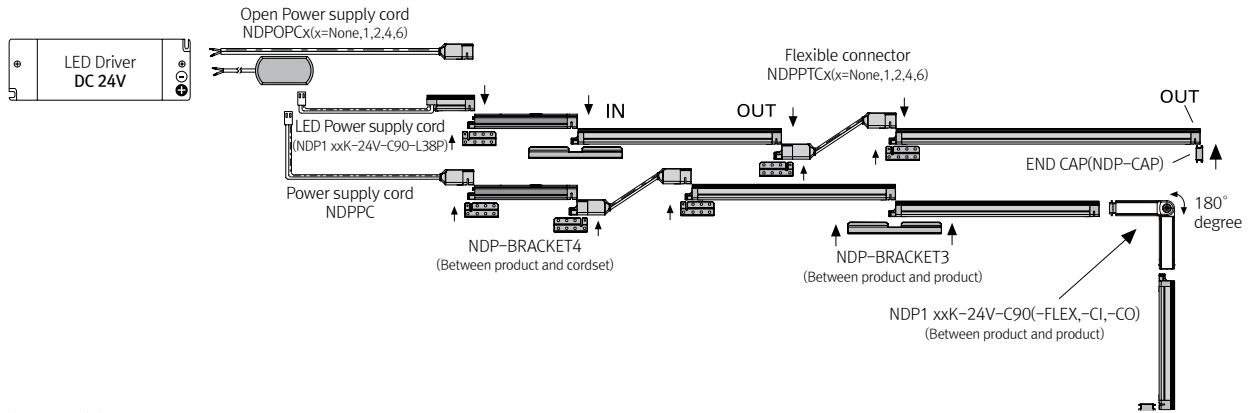

SIDE FEED UNIT

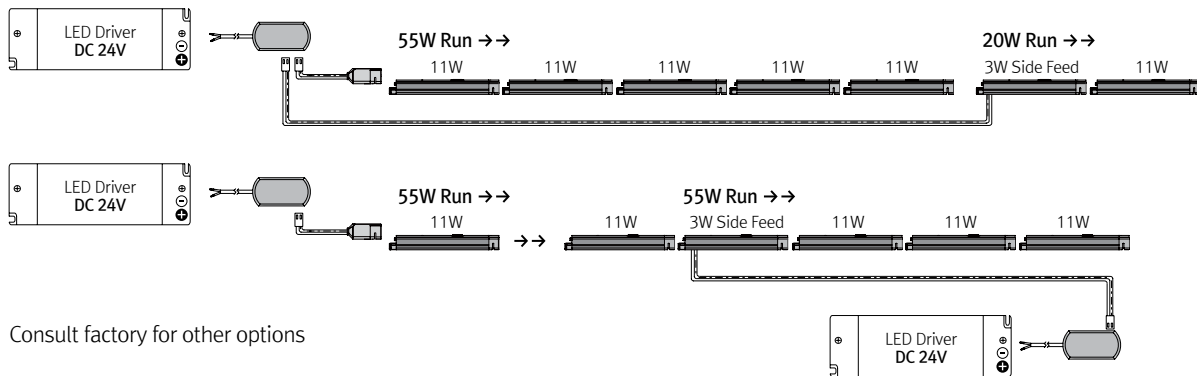

Consult factory for other options

CAN POWER UP TO 55 WATT MAX FIXTURE LOAD. CONNECTED LINE OF LIGHT REQUIRES SIDE FEED EVERY 15FT(55WATT). TOTAL CONNECTED LOAD SHOULD NOT EXCEED 90% OF DRIVER WATTS

BEAM SPREADS

NDP1 40K-24V-C90

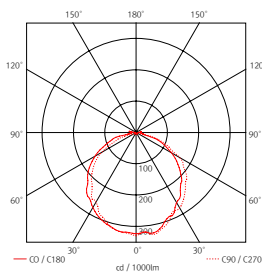

NDP3 40K-24V-C90

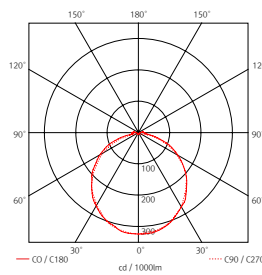

NDP4 40K-24V-C90

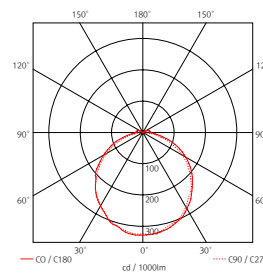

NDP7 40K-24V-C90

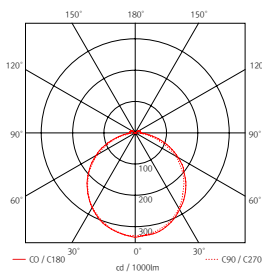

NDP11 40K-24V-C90

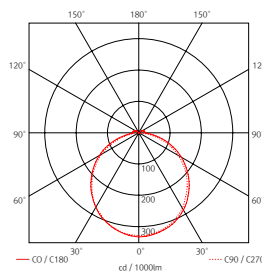

NDP15 40K-24V-C90

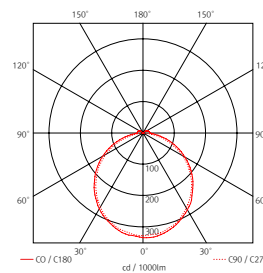

COMPONENTS

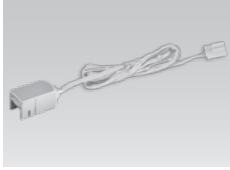

Power cable
 __NDPPC (2,500mm)
 __NDPPC (4,000mm)



Occupancy Sensor
 __NDP-OSM
 NDP Occupancy Sensor
 Inline Module



12 Port Hub
 __12 Way distributor
 Included with Cord and Plug
 drivers. Order separately for
 3rd Party Drivers

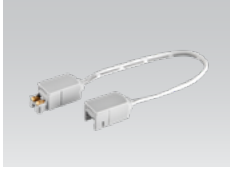

Connecting Cable
 __NDPPTC (150mm)
 __NDPPTC1 (300mm)
 __NDPPTC2 (600mm)
 __NDPPTC4 (1,200mm)
 __NDPPTC6 (1,800mm)



Touch Switch
 __NDPTS
 NDP ON/OFF touch switch

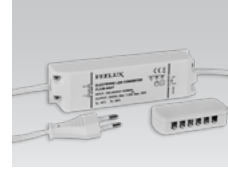

LED Drivers
 __FLC30-24V/T (30W)
 __FLC75-24V/T (75W)
 with distributor and power
 cord (1,800mm)



LED Power cable
 __NDP1-(color)K 24V-C90-
 L38P
 2,500mm cable
 Lighted section 36mm



End Cap
 __NDP-CAP
 Included with fixture

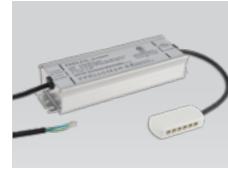

LED Driver
 __FLC200-24V/T (200W)
 with 12way distributor



**Sidefeed for Seamless
 Extension (3W)**
 __NDP3-(color)K-24V-S

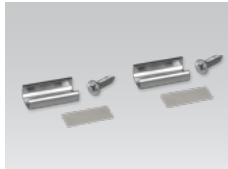

**Metal Mounting
 Brackets**
 __NDV-BRACKET1
 Included with fixture



**Dimming Interface
 (0-10V/1-10V)**
 __FDC-L10 (Max. 100W)



Flexible Connector
 __NDP1-(color)K-24V-FLEX



Angled Brackets
 __NDV-BRACKET2
 Angled 15° /40° (BK2)
 Optional



Dimming Interface
 __FDA-L2MO
 (0-10V/1-10V, DMX512)
 Max. 200W (100W/CH, 2CH)
 __FDA-L5M (DMX512)
 Max. 200W (50W/CH, 5CH)

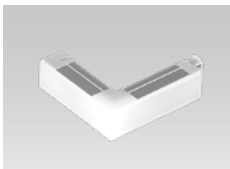

Corner Out Connector
 __NDP1-(color)K-24V-
 C90-CO



Connecting Brackets
 __NDV-BRACKET3
 Fixture to Fixture
 Included with fixture



Dimming Interface (Dail)
 __FDD-L1DA
 Max. 200W (100W/CH, 1CH)



Corner In Connector
 __NDP1-(color)K-24V-
 C90-CI



Power Brackets
 __NDV-BRACKET4
 Included with NDPPC
 and NDPPTC



**Door and motion
 sensor**
 __FLS-M24V



In-Line Dimmer
 __NDPDIM
 (Max 55W in a row)



Magnet Brackets
 __NDP-BRACKET-M

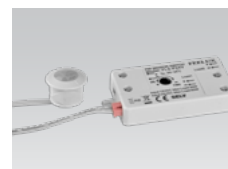

Occupancy sensor
 __FLS-P24V